

ProDesk® 60 Electric



We created the ProDesk® 60 Electric with contract-grade materials and designed it to do something no other electric standing desk can do – assemble in under 5 minutes while being incredibly stable at any height. Each desk is designed to last, featuring a sturdy frame with a steel crossbar for enhanced stability and a heavy-duty laminate finish. Its unique legs, with our patent-pending, easy-to-attach feature, mean it takes less than 5 minutes to assemble. Memory settings and an LED display make it easy to adjust to any height from 25.5" – 50.5". With multiple finishes that showcase its stylish chamfered edges, there's a look that's sure to fit your style.

- Assembles in 5 Minutes or Less
- Supports up to 250 lb (113.4 kg)
- 2 Programmable Memory Settings with LED Display
- A Steel Crossbar for Enhanced Stability
- Cable Management Tray

Top Finishes:
Leg Finishes:



Black
Slate



White
Silver



Darkwood
Slate



Butcher Block
Slate



Reclaimed Wood
Slate

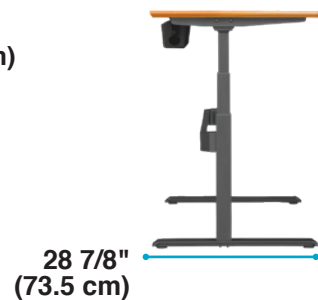
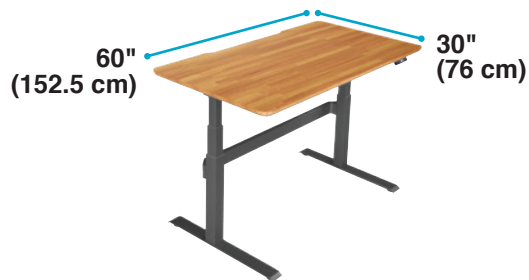

Height Settings:
25 1/2" (65 cm) to 50 1/2" (129 cm)

