

VariDesk® Pro Plus™ 30



No Tools
Required



Holds up to
35 lb (15.8 kg)

vari®

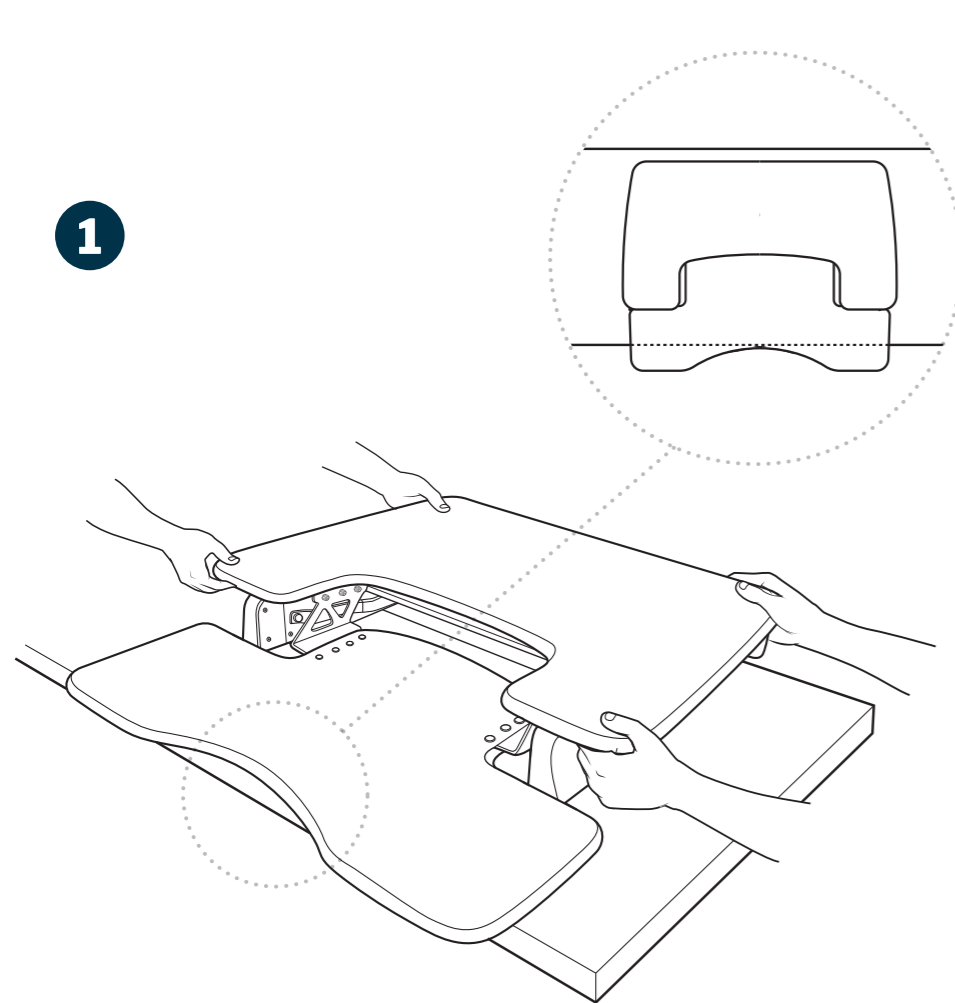

1 With another person's assistance, place your VariDesk® converter on top of your existing desk with the curve of the base flush with the desk.

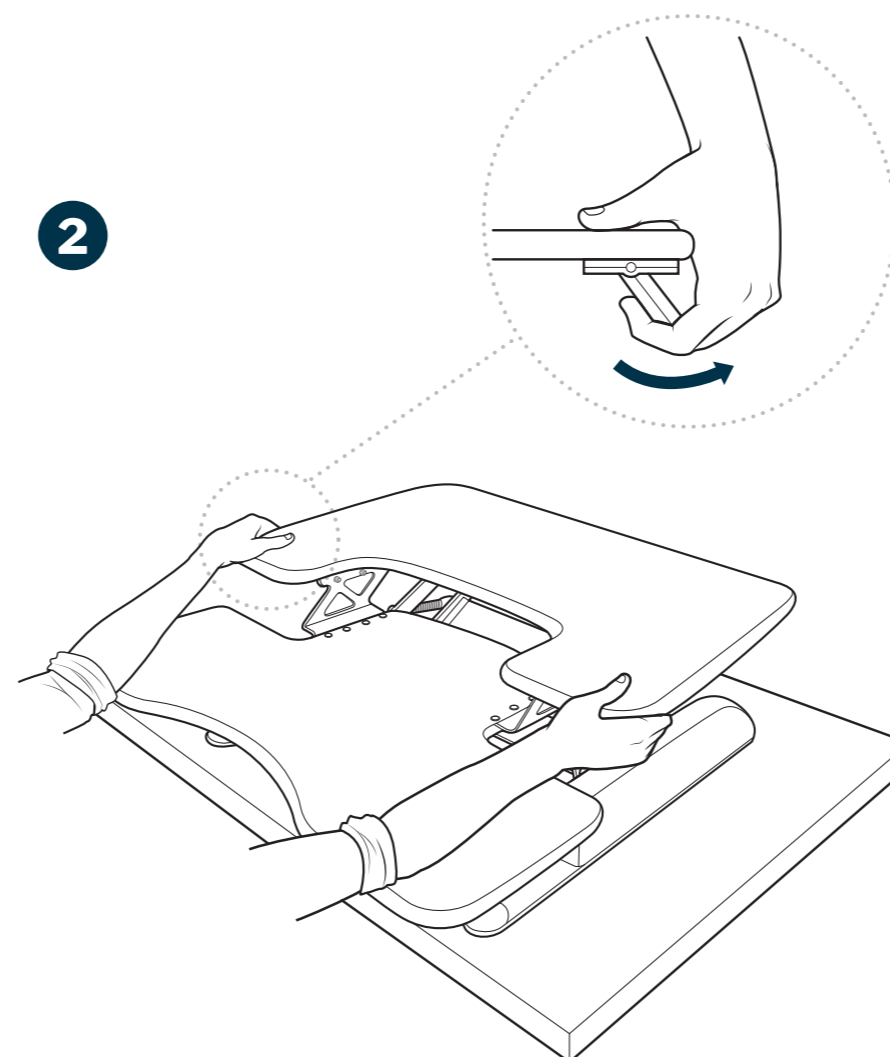

2 To raise, stand with one foot in front of the other with feet about shoulder width apart, knees slightly bent and weight on your front leg, then reach down and grab both handles.

Squeeze the handles, and while keeping your back and spine straight, lift and pull upward toward your torso. As you do, shift your weight to your back leg and take a step back.

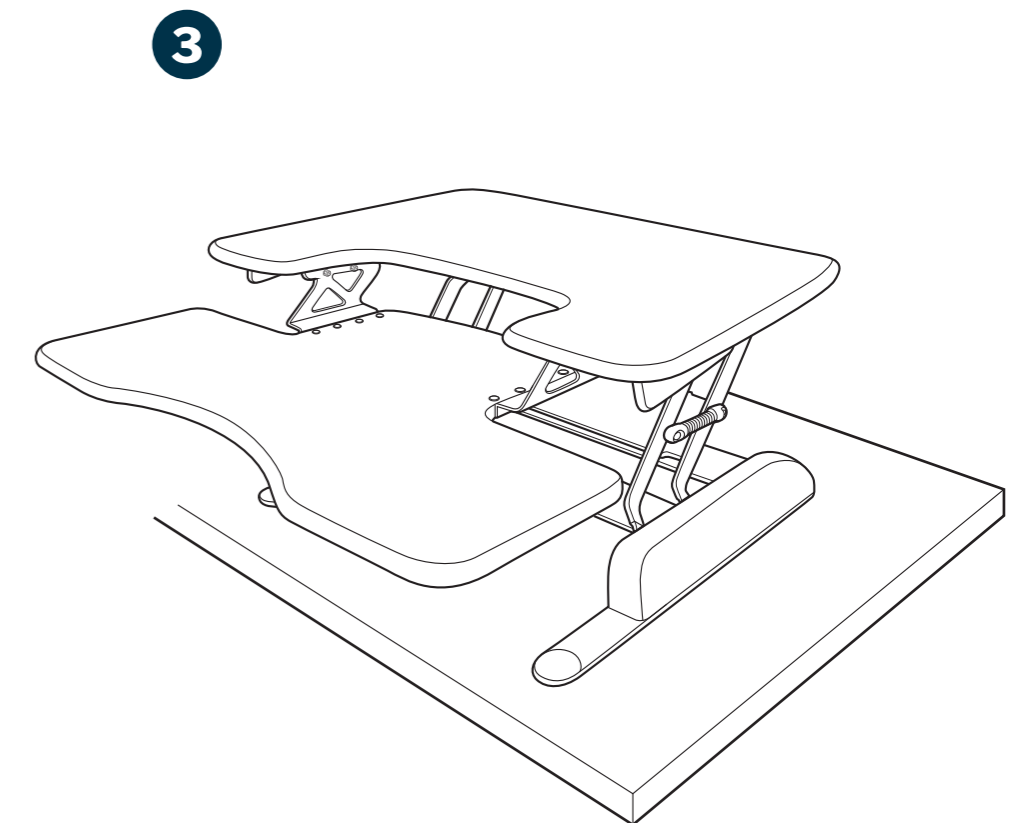

3 Release the handles at your preferred height, then press down lightly to lock the converter into place. When standing, elbows should be bent 90 degrees with wrists in a neutral position.

